

THE INFORMATION CONTAINED IN THIS DRAWING IS THE SOLE PROPERTY OF GREENFIELD MFG CO ANY REPRODUCTION IN PART OR WHOLE WITHOUT THE WRITTEN PERMISSION OF GREENFIELD MFG CO IS PROHIBITED.

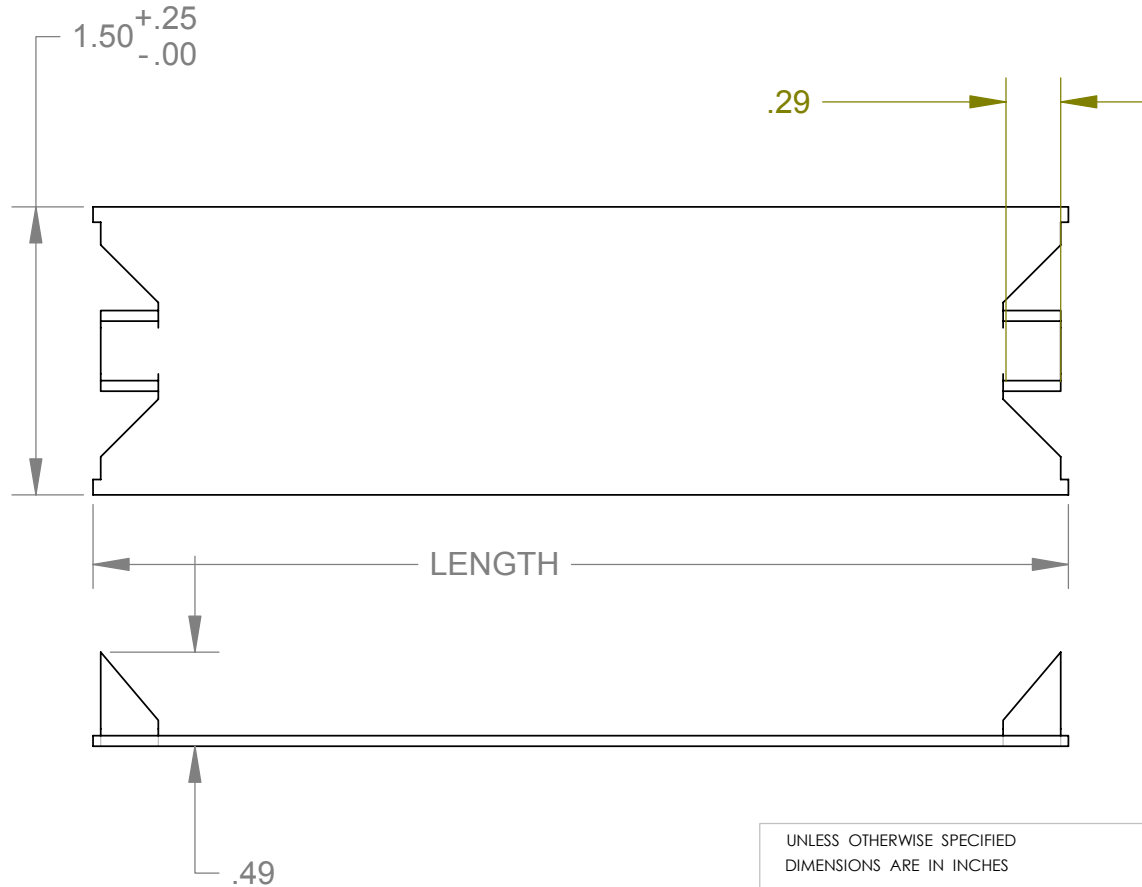
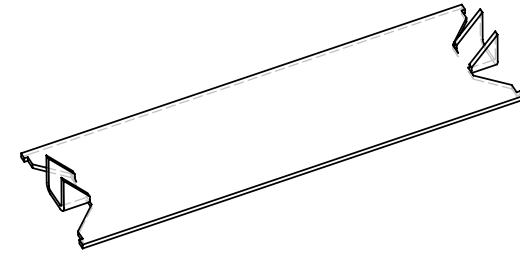

LENGTHS AVAILABLE = 3, 5, 6

P/N= 531 - LENGTH
EXAMPLE: 531 - 6
FOR 6 INCH PART

Made in USA

UNLESS OTHERWISE SPECIFIED DIMENSIONS ARE IN INCHES TOLERANCES ARE: +/- .03	CAD GENERATED DRAWING, DO NOT MANUALLY UPDATE		GREENFIELD MFG CO	
	APPROVALS	DATE	920 LEVICK ST , PHILA.,PA. 19111	
MATERIAL 20 GA .032 MIN	DRAWN EG		P/N	STUD GUARD
FINISH	CHECKED SB		A	FIG 531 REV.
DO NOT SCALE DRAWING	SCALE	CAD FILE:	SHEET	OF